

BUL45G

NPN Silicon Power Transistor

High Voltage SWITCHMODE™ Series

Designed for use in electronic ballast (light ballast) and in Switchmode Power supplies up to 50 Watts.

Features

- Improved Efficiency Due to:
 - ◆ Low Base Drive Requirements (High and Flat DC Current Gain h_{FE})
 - ◆ Low Power Losses (On-State and Switching Operations)
 - ◆ Fast Switching: $t_{fi} = 100$ ns (typ) and $t_{si} = 3.2$ μ s (typ)
 - ◆ @ $I_C = 2.0$ A, $I_{B1} = I_{B2} = 0.4$ A
- Full Characterization at 125°C
- Tight Parametric Distributions Consistent Lot-to-Lot
- These Devices are Pb-Free and are RoHS Compliant*

MAXIMUM RATINGS

Rating	Symbol	Value	Unit
Collector-Emitter Sustaining Voltage	V_{CEO}	400	Vdc
Collector-Base Breakdown Voltage	V_{CES}	700	Vdc
Emitter-Base Voltage	V_{EBO}	9.0	Vdc
Collector Current – Continuous – Peak (Note 1)	I_C I_{CM}	5.0 10	Adc
Base Current	I_B	2.0	Adc
Total Device Dissipation @ $T_C = 25^\circ\text{C}$ Derate above 25°C	P_D	75 0.6	W W/°C
Operating and Storage Temperature	T_J, T_{stg}	-65 to 150	°C

THERMAL CHARACTERISTICS

Characteristics	Symbol	Max	Unit
Thermal Resistance, Junction-to-Case	$R_{\theta JC}$	1.65	°C/W
Thermal Resistance, Junction-to-Ambient	$R_{\theta JA}$	62.5	°C/W

Stresses exceeding Maximum Ratings may damage the device. Maximum Ratings are stress ratings only. Functional operation above the Recommended Operating Conditions is not implied. Extended exposure to stresses above the Recommended Operating Conditions may affect device reliability.

1. Pulse Test: Pulse Width = 5 ms, Duty Cycle \leq 10%.



ON Semiconductor®

<http://onsemi.com>

POWER TRANSISTOR
5.0 AMPERES, 700 VOLTS,
35 AND 75 WATTS

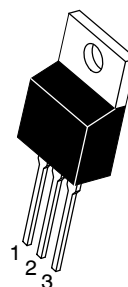

TO-220AB
CASE 221A-09
STYLE 1

MARKING DIAGRAM

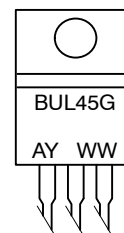

BUL45 = Device Code
A = Assembly Location
Y = Year
WW = Work Week
G = Pb-Free Package

ORDERING INFORMATION

Device	Package	Shipping
BUL45G	TO-220 (Pb-Free)	50 Units / Rail

*For additional information on our Pb-Free strategy and soldering details, please download the ON Semiconductor Soldering and Mounting Techniques Reference Manual, SOLDERRM/D.

BUL45G

ELECTRICAL CHARACTERISTICS (T_C = 25°C unless otherwise noted)

Characteristic	Symbol	Min	Typ	Max	Unit
----------------	--------	-----	-----	-----	------

OFF CHARACTERISTICS

Collector-Emitter Sustaining Voltage (I _C = 100 mA, L = 25 mH)	V _{CEO(sus)}	400	-	-	Vdc
Collector Cutoff Current (V _{CE} = Rated V _{CEO} , I _B = 0)	I _{CEO}	-	-	100	μAdc
Collector Cutoff Current (V _{CE} = Rated V _{CES} , V _{EB} = 0) (T _C = 125°C)	I _{CES}	-	-	10 100	μAdc
Emitter Cutoff Current (V _{EB} = 9.0 Vdc, I _C = 0)	I _{EBO}	-	-	100	μAdc

ON CHARACTERISTICS

Base-Emitter Saturation Voltage (I _C = 1.0 Adc, I _B = 0.2 Adc) (I _C = 2.0 Adc, I _B = 0.4 Adc)	V _{BE(sat)}	-	0.84 0.89	1.2 1.25	Vdc
Collector-Emitter Saturation Voltage (I _C = 1.0 Adc, I _B = 0.2 Adc) (T _C = 125°C)	V _{CE(sat)}	-	0.175 0.150	0.25 -	Vdc
Collector-Emitter Saturation Voltage (I _C = 2.0 Adc, I _B = 0.4 Adc) (T _C = 125°C)	V _{CE(sat)}	-	0.25 0.275	0.4 -	Vdc
DC Current Gain (I _C = 0.3 Adc, V _{CE} = 5.0 Vdc) (I _C = 2.0 Adc, V _{CE} = 1.0 Vdc) (I _C = 10 mAdc, V _{CE} = 5.0 Vdc)	h _{FE}	14 - 7.0 5.0 10	- 32 14 12 22	34 - - - -	-

DYNAMIC CHARACTERISTICS

Current Gain Bandwidth (I _C = 0.5 Adc, V _{CE} = 10 Vdc, f = 1.0 MHz)	f _T	-	12	-	MHz		
Output Capacitance (V _{CB} = 10 Vdc, I _E = 0, f = 1.0 MHz)	C _{ob}	-	50	75	pF		
Input Capacitance (V _{EB} = 8.0 Vdc)	C _{ib}	-	920	1200	pF		
Dynamic Saturation Voltage: Determined 1.0 μs and 3.0 μs respectively after rising I _{B1} reaches 90% of final I _{B1} (see Figure 18)	V _{CE} (Dyn sat)	(I _C = 1.0 Adc I _{B1} = 100 mAdc V _{CC} = 300 V)	1.0 μs (T _C = 125°C)	-	1.75 4.4	-	Vdc
			3.0 μs (T _C = 125°C)	-	0.5 1.0	-	
		(I _C = 2.0 Adc I _{B1} = 400 mAdc V _{CC} = 300 V)	1.0 μs (T _C = 125°C)	-	1.85 6.0	-	
			3.0 μs (T _C = 125°C)	-	0.5 1.0	-	

SWITCHING CHARACTERISTICS: Resistive Load

Turn-On Time	(I _C = 2.0 Adc, I _{B1} = I _{B2} = 0.4 Adc Pulse Width = 20 μs, (T _C = 125°C)	t _{on}	-	75 120	110 -	ns
Turn-Off Time	Duty Cycle < 20% V _{CC} = 300 V (T _C = 125°C)	t _{off}	-	2.8 3.5	3.5 -	μs

SWITCHING CHARACTERISTICS: Inductive Load (V_{CC} = 15 Vdc, L_C = 200 μH, V_{clamp} = 300 Vdc)

Fall Time	(I _C = 2.0 Adc, I _{B1} = 0.4 Adc I _{B2} = 0.4 Adc (T _C = 125°C)	t _{fi}	70 -	- 200	170 -	ns
Storage Time		t _{si}	2.6 -	- 4.2	3.8 -	μs
Crossover Time		t _c	- -	230 400	350 -	ns
Fall Time	(I _C = 1.0 Adc, I _{B1} = 100 mAdc I _{B2} = 0.5 Adc (T _C = 125°C)	t _{fi}	- -	110 100	150 -	ns
Storage Time		t _{si}	- -	1.1 1.5	1.7 -	μs
Crossover Time		t _c	- -	170 170	250 -	ns
Fall Time	(I _C = 2.0 Adc, I _{B1} = 250 mAdc I _{B2} = 2.0 Adc (T _C = 125°C)	t _{fi}	-	80	120	ns
Storage Time		t _{si}	-	0.6	0.9	μs
Crossover Time		t _c	-	175	300	ns

BUL45G

TYPICAL STATIC CHARACTERISTICS

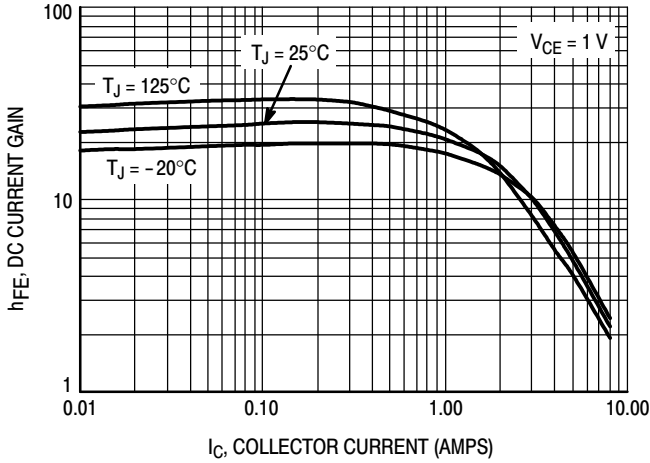

Figure 1. DC Current Gain @ 1 Volt

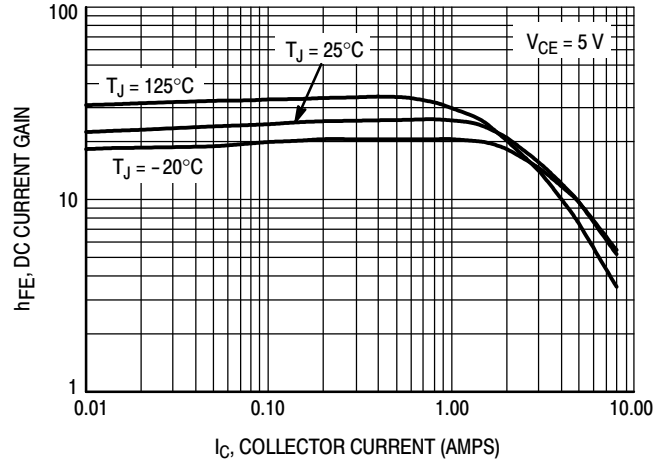

Figure 2. DC Current Gain at @ 5 Volts

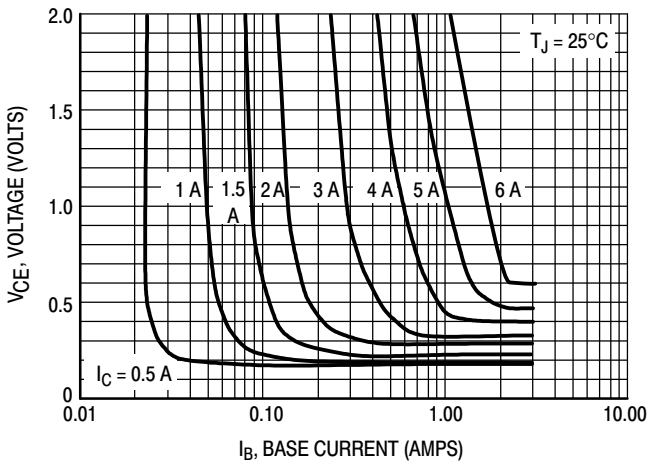

Figure 3. Collector-Emitter Saturation Region

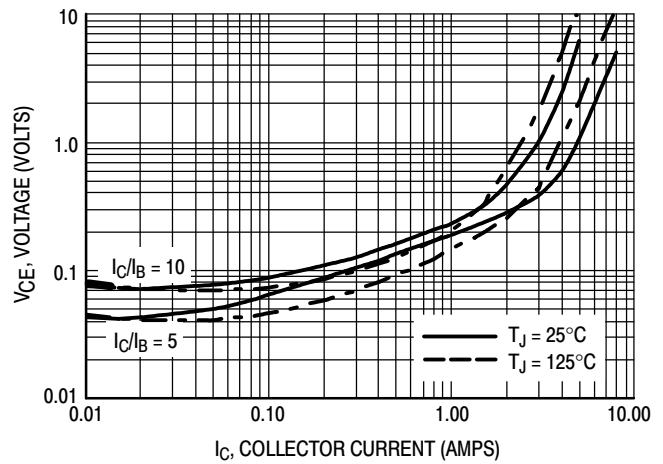

Figure 4. Collector-Emitter Saturation Voltage

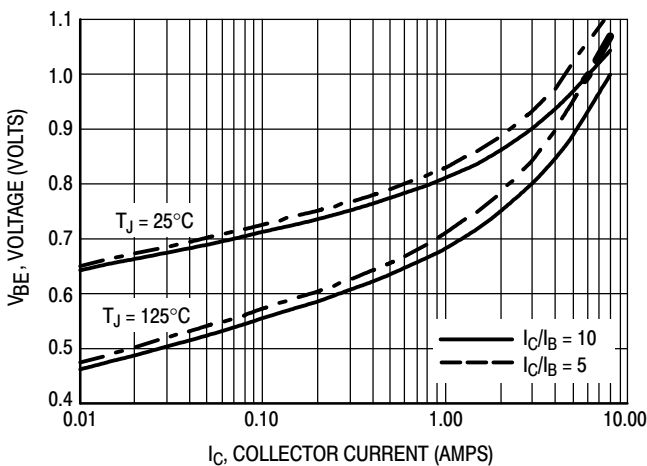

Figure 5. Base-Emitter Saturation Region

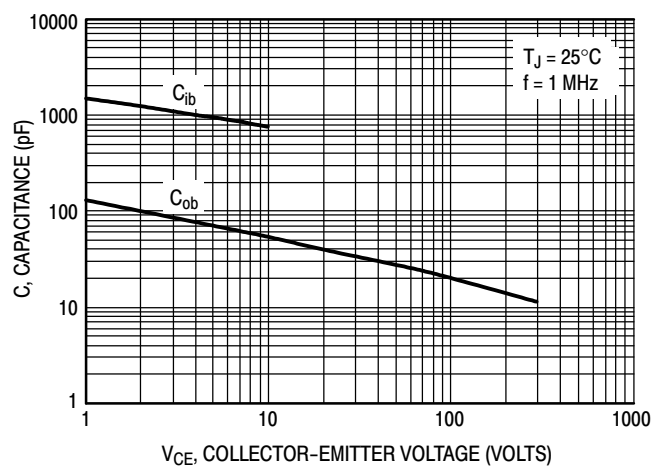

Figure 6. Capacitance

TYPICAL SWITCHING CHARACTERISTICS
($I_{B2} = I_C/2$ for all switching)

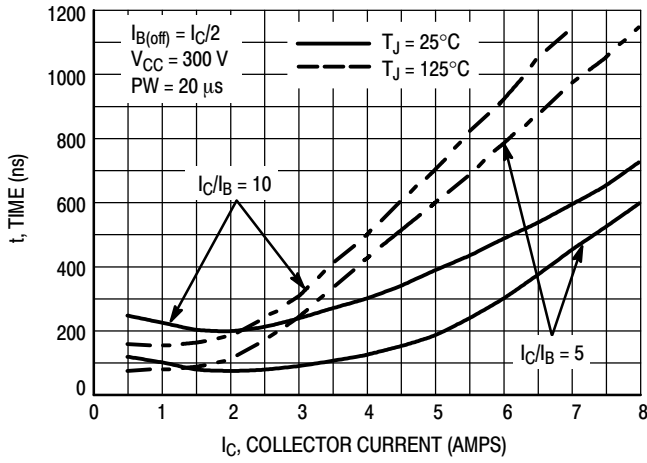

Figure 7. Resistive Switching, t_{on}

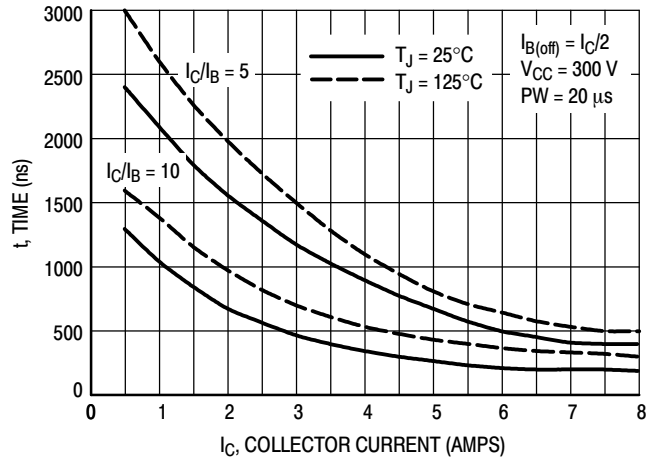

Figure 8. Resistive Switching, t_{off}

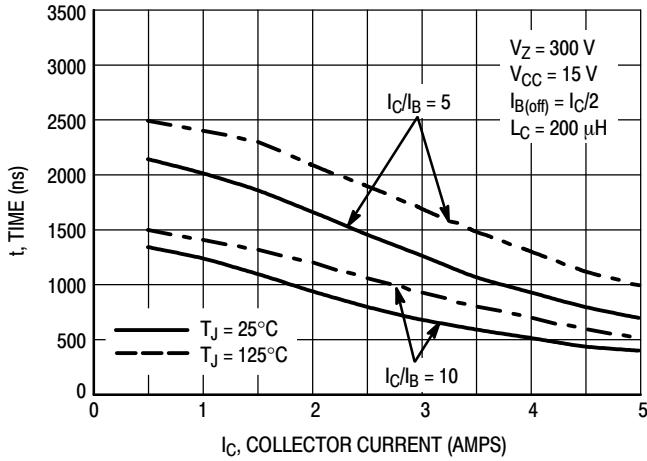

Figure 9. Inductive Storage Time, t_{si}

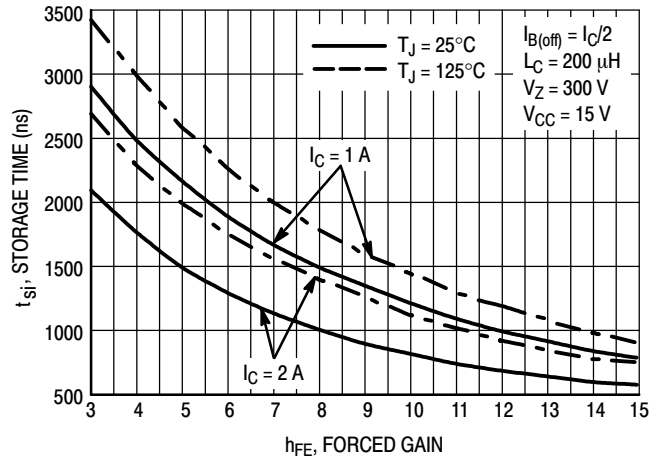

Figure 10. Inductive Storage Time, $t_{si}(h_{FE})$

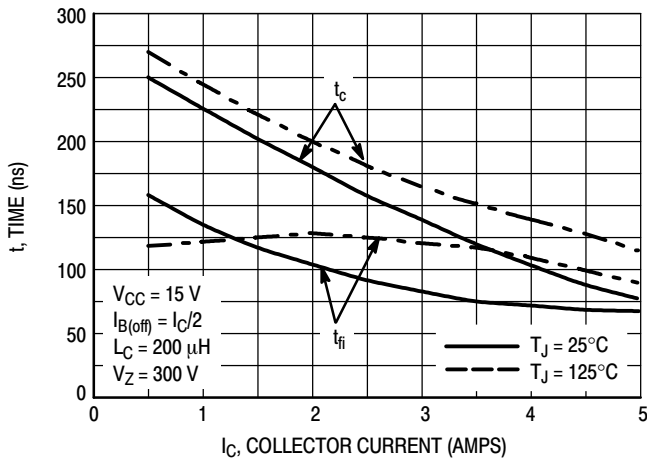

Figure 11. Inductive Switching, t_c & t_{fi} , $I_C/I_B = 5$

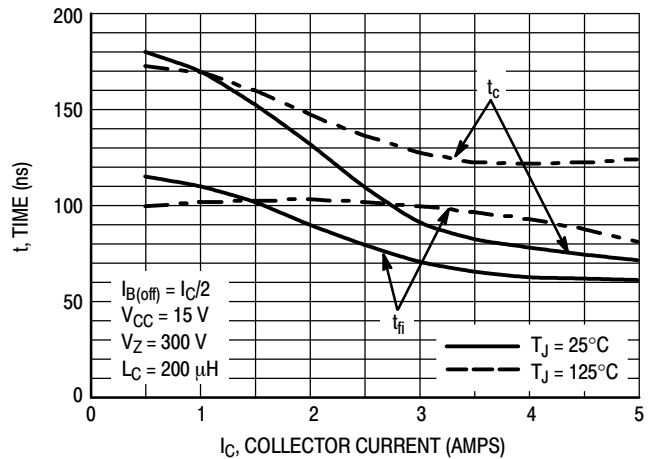

Figure 12. Inductive Switching, t_c & t_{fi} , $I_C/I_B = 10$

TYPICAL SWITCHING CHARACTERISTICS
($I_{B2} = I_C/2$ for all switching)

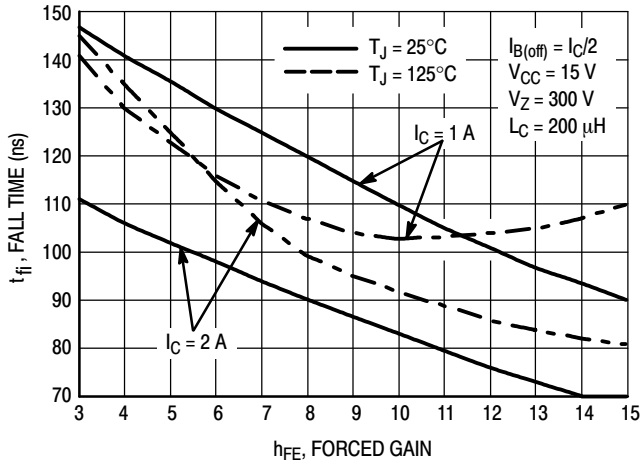

Figure 13. Inductive Fall Time, $t_{fi}(h_{FE})$

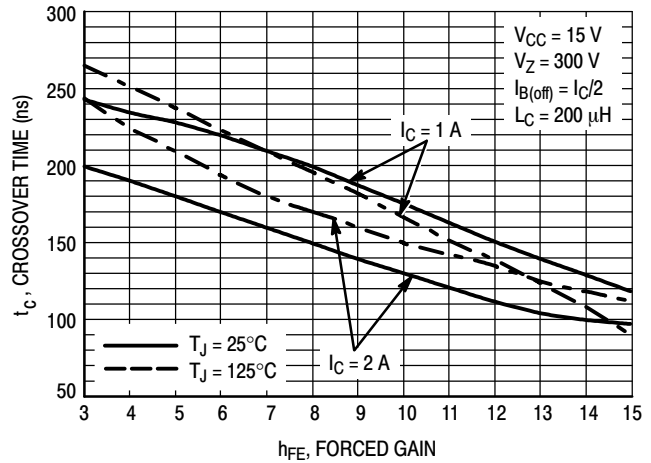

Figure 14. Crossover Time

GUARANTEED SAFE OPERATING AREA INFORMATION

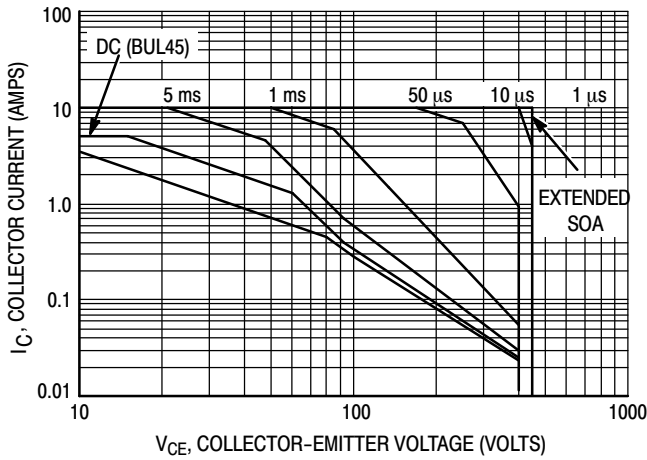

Figure 15. Forward Bias Safe Operating Area

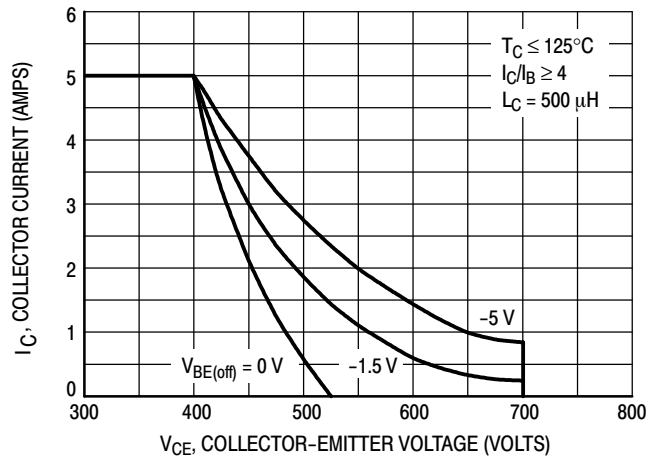

Figure 16. Reverse Bias Switching Safe Operating Area

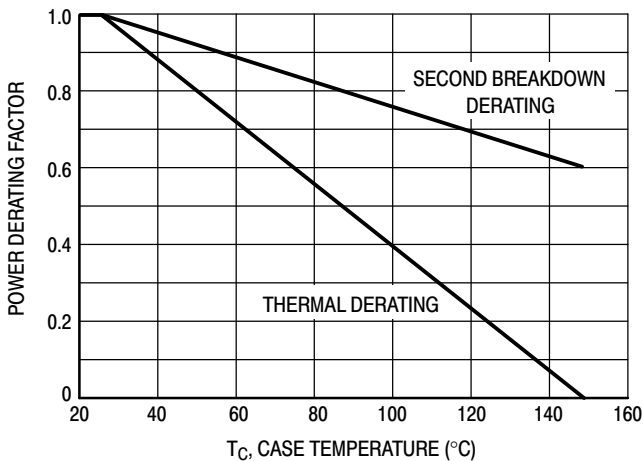

Figure 17. Forward Bias Power Derating

There are two limitations on the power handling ability of a transistor: average junction temperature and second breakdown. Safe operating area curves indicate $I_C - V_{CE}$ limits of the transistor that must be observed for reliable operation; i.e., the transistor must not be subjected to greater dissipation than the curves indicate. The data of Figure 15 is based on $T_C = 25^\circ\text{C}$; $T_{J(pk)}$ is variable depending on power level. Second breakdown pulse limits are valid for duty cycles to 10% but must be derated when $T_C \geq 25^\circ\text{C}$. Second breakdown limitations do not derate the same as thermal limitations. Allowable current at the voltages shown in Figure 15 may be found at any case temperature by using the appropriate curve on Figure 17. $T_{J(pk)}$ may be calculated from the data in Figures 20. At any case temperatures, thermal limitations will reduce the power that can be handled to values less than the limitations imposed by second breakdown. For inductive loads, high voltage and current must be sustained simultaneously during turn-off with the base-to-emitter junction reverse-biased. The safe level is specified as a reverse-biased safe operating area (Figure 16). This rating is verified under clamped conditions so that the device is never subjected to an avalanche mode.

BUL45G

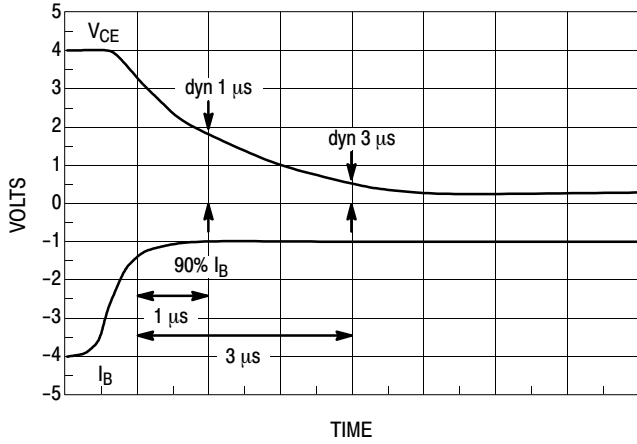

Figure 18. Dynamic Saturation Voltage Measurements

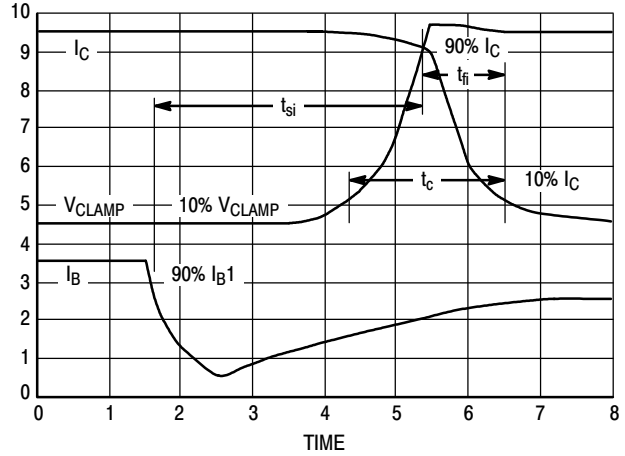
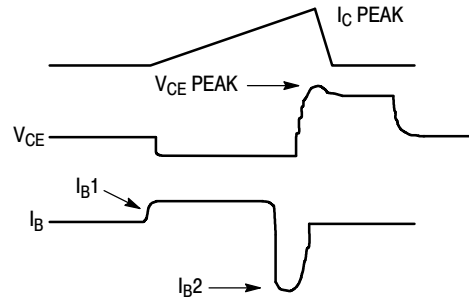
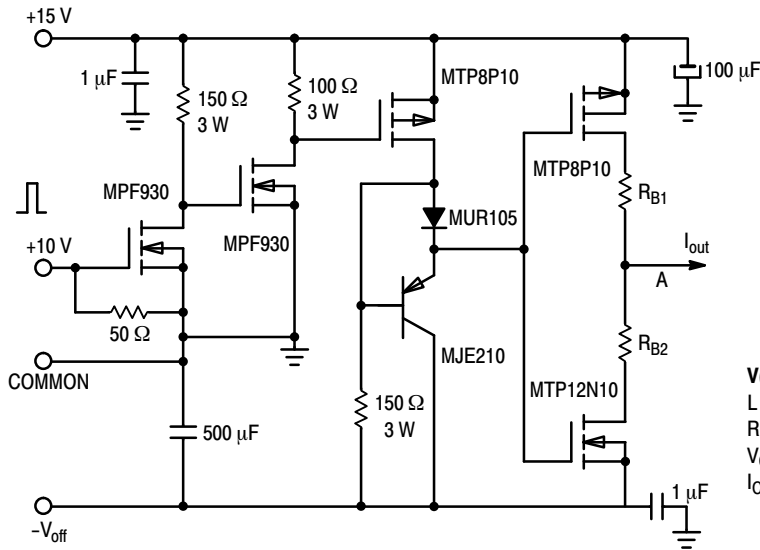

Figure 19. Inductive Switching Measurements



V(BR)CEO(sus)	INDUCTIVE SWITCHING	RBSOA
L = 10 mH	L = 200 μH	L = 500 μH
RB2 = ∞	RB2 = 0	RB2 = 0
VCC = 20 VOLTS	VCC = 15 VOLTS	VCC = 15 VOLTS
IC(pk) = 100 mA	RB1 SELECTED FOR DESIRED IB1	RB1 SELECTED FOR DESIRED IB1

Table 1. Inductive Load Switching Drive Circuit

TYPICAL THERMAL RESPONSE

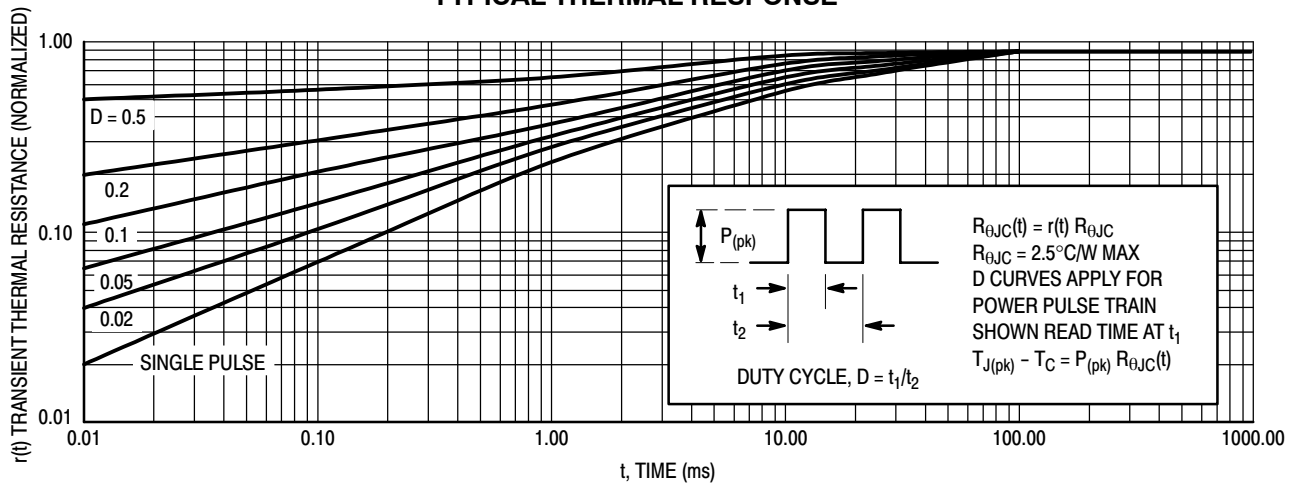
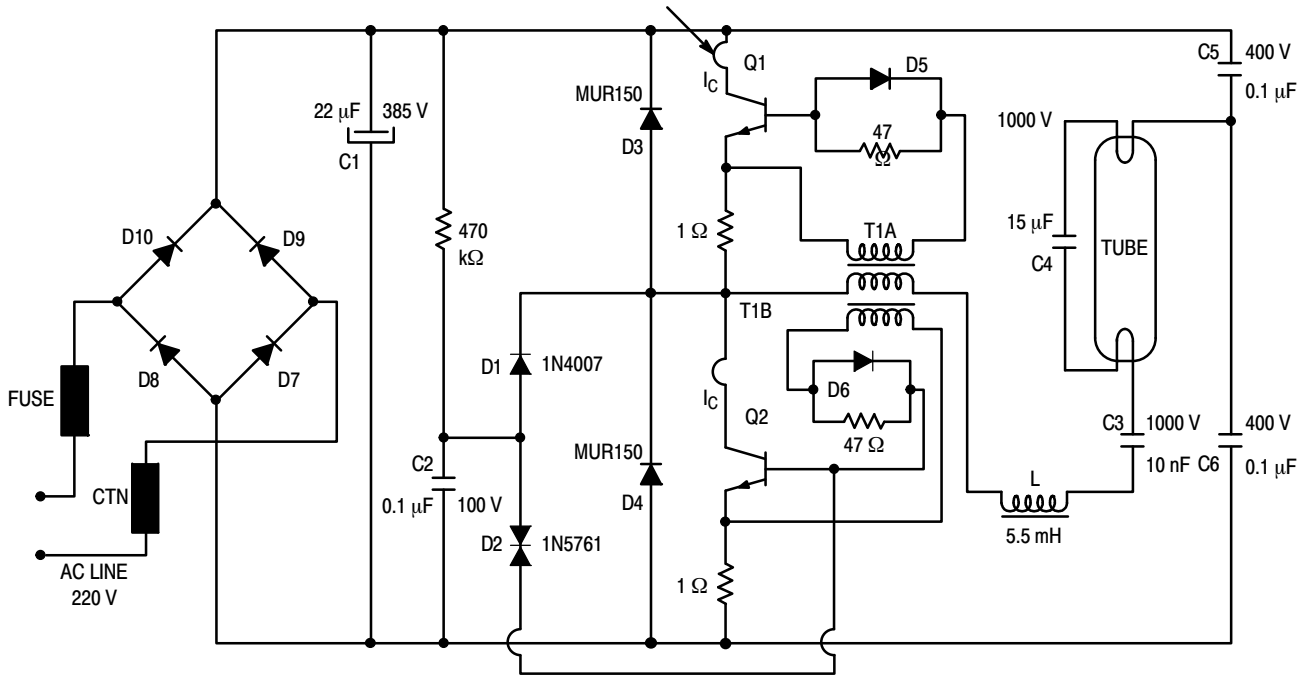

Figure 20. Typical Thermal Response ($Z_{\theta JC}(t)$) for BUL45

BUL45G

The BUL45 Bipolar Power Transistors were specially designed for use in electronic lamp ballasts. A circuit designed by ON Semiconductor applications was built to

demonstrate how well these devices operate. The circuit and detailed component list are provided below.



Components Lists

Q1 = Q2 = BUL45 Transistor
 D1 = 1N4007 Rectifier
 D2 = 1N5761 Rectifier
 D3 = D4 = MUR150
 D5 = D6 = MUR105
 D7 = D8 = D9 = D10 = 1N400
 CTN = 47 Ω @ 25°C
 L = RM10 core, A1 = 400, B51 (LCC) 75 turns,
 wire \varnothing = 0.6 mm
 T1 = FT10 toroid, T4A (LCC)
 Primary: 4 turns
 Secondaries: T1A: 4 turns
 T1B: 4 turns

All resistors are 1/4 Watt, $\pm 5\%$

R1 = 470 k Ω
 R2 = R3 = 47 Ω
 R4 = R5 = 1 Ω (these resistors are optional, and
 might be replaced by a short circuit)
 C1 = 22 μ F/385 V
 C2 = 0.1 μ F
 C3 = 10 nF/1000 V
 C4 = 15 nF/1000 V
 C5 = C6 = 0.1 μ F/400 V

NOTES:

1. Since this design does not include the line input filter, it cannot be used "as-is" in a practical industrial circuit.
2. The windings are given for a 55 Watt load. For proper operation they must be re-calculated with any other loads.

Figure 21. Application Example

BUL45G

PACKAGE DIMENSIONS

TO-220AB
CASE 221A-09
ISSUE AF

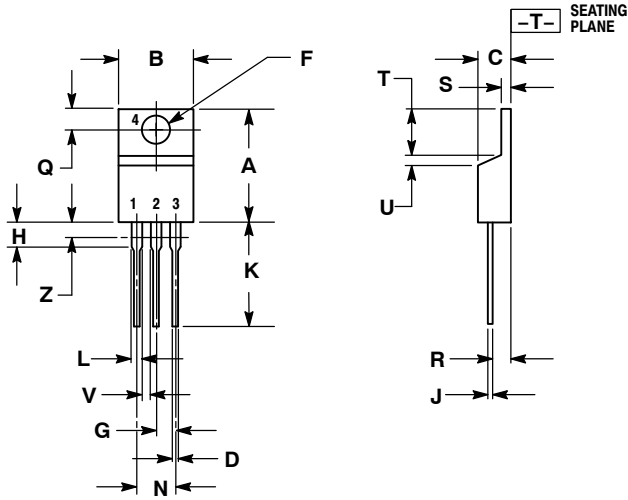

NOTES:

1. DIMENSIONING AND TOLERANCING PER ANSI Y14.5M, 1982.
2. CONTROLLING DIMENSION: INCH.
3. DIMENSION Z DEFINES A ZONE WHERE ALL BODY AND LEAD IRREGULARITIES ARE ALLOWED.

DIM	INCHES		MILLIMETERS	
	MIN	MAX	MIN	MAX
A	0.570	0.620	14.48	15.75
B	0.380	0.405	9.66	10.28
C	0.160	0.190	4.07	4.82
D	0.025	0.035	0.64	0.88
F	0.142	0.161	3.61	4.09
G	0.095	0.105	2.42	2.66
H	0.110	0.155	2.80	3.93
J	0.014	0.025	0.36	0.64
K	0.500	0.562	12.70	14.27
L	0.045	0.060	1.15	1.52
N	0.190	0.210	4.83	5.33
Q	0.100	0.120	2.54	3.04
R	0.080	0.110	2.04	2.79
S	0.045	0.055	1.15	1.39
T	0.235	0.255	5.97	6.47
U	0.000	0.050	0.00	1.27
V	0.045	---	1.15	---
Z	---	0.080	---	2.04

STYLE 1:

1. BASE
2. COLLECTOR
3. EMITTER
4. COLLECTOR

SWITCHMODE is a trademark of Semiconductor Components Industries, LLC.

ON Semiconductor and are registered trademarks of Semiconductor Components Industries, LLC (SCILLC). SCILLC reserves the right to make changes without further notice to any products herein. SCILLC makes no warranty, representation or guarantee regarding the suitability of its products for any particular purpose, nor does SCILLC assume any liability arising out of the application or use of any product or circuit, and specifically disclaims any and all liability, including without limitation special, consequential or incidental damages. "Typical" parameters which may be provided in SCILLC data sheets and/or specifications can and do vary in different applications and actual performance may vary over time. All operating parameters, including "Typicals" must be validated for each customer application by customer's technical experts. SCILLC does not convey any license under its patent rights nor the rights of others. SCILLC products are not designed, intended, or authorized for use as components in systems intended for surgical implant into the body, or other applications intended to support or sustain life, or for any other application in which the failure of the SCILLC product could create a situation where personal injury or death may occur. Should Buyer purchase or use SCILLC products for any such unintended or unauthorized application, Buyer shall indemnify and hold SCILLC and its officers, employees, subsidiaries, affiliates, and distributors harmless against all claims, costs, damages, and expenses, and reasonable attorney fees arising out of, directly or indirectly, any claim of personal injury or death associated with such unintended or unauthorized use, even if such claim alleges that SCILLC was negligent regarding the design or manufacture of the part. SCILLC is an Equal Opportunity/Affirmative Action Employer. This literature is subject to all applicable copyright laws and is not for resale in any manner.

PUBLICATION ORDERING INFORMATION

LITERATURE FULFILLMENT:

Literature Distribution Center for ON Semiconductor
P.O. Box 5163, Denver, Colorado 80217 USA
Phone: 303-675-2175 or 800-344-3860 Toll Free USA/Canada
Fax: 303-675-2176 or 800-344-3867 Toll Free USA/Canada
Email: orderlit@onsemi.com

N. American Technical Support: 800-282-9855 Toll Free
USA/Canada
Europe, Middle East and Africa Technical Support:
Phone: 421 33 790 2910
Japan Customer Focus Center
Phone: 81-3-5773-3850

ON Semiconductor Website: www.onsemi.com

Order Literature: <http://www.onsemi.com/orderlit>

For additional information, please contact your local Sales Representative